

SCHEMATIC CARDS

V 0.1 CC BT-SA 4.0

Tommy@ostk.com

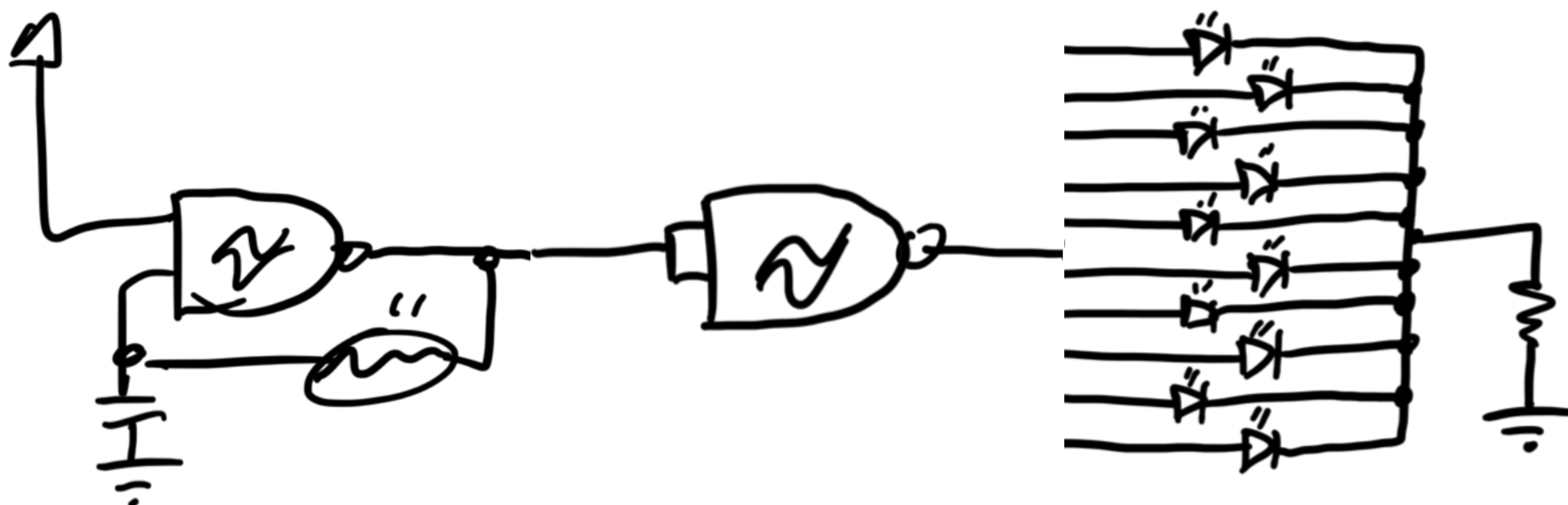

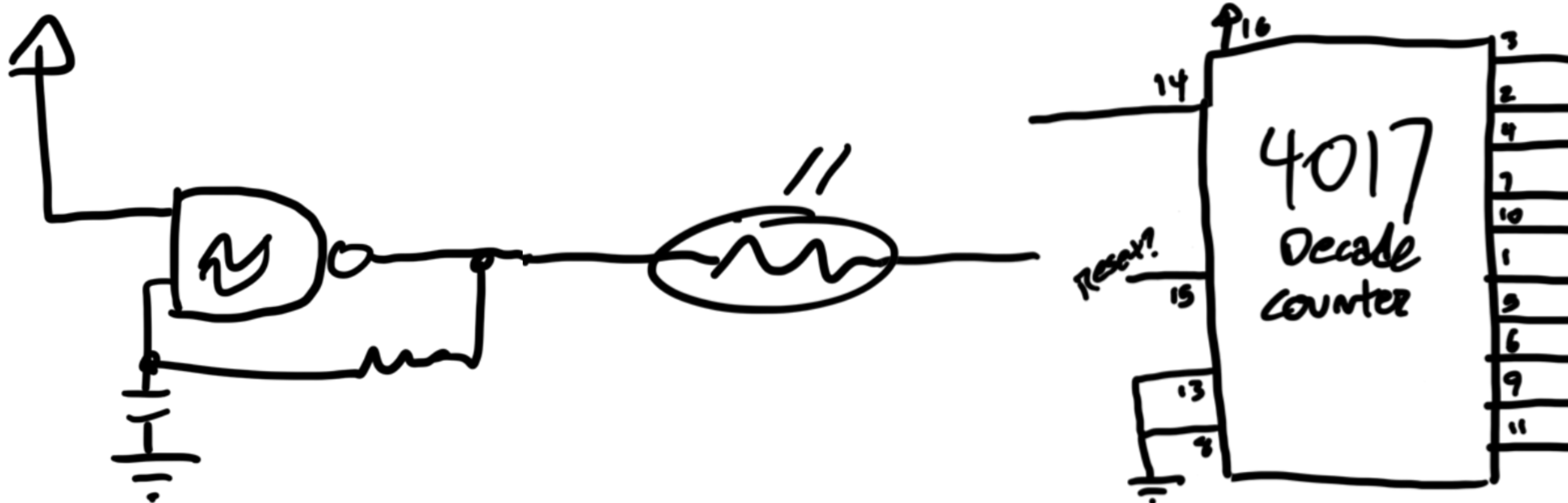
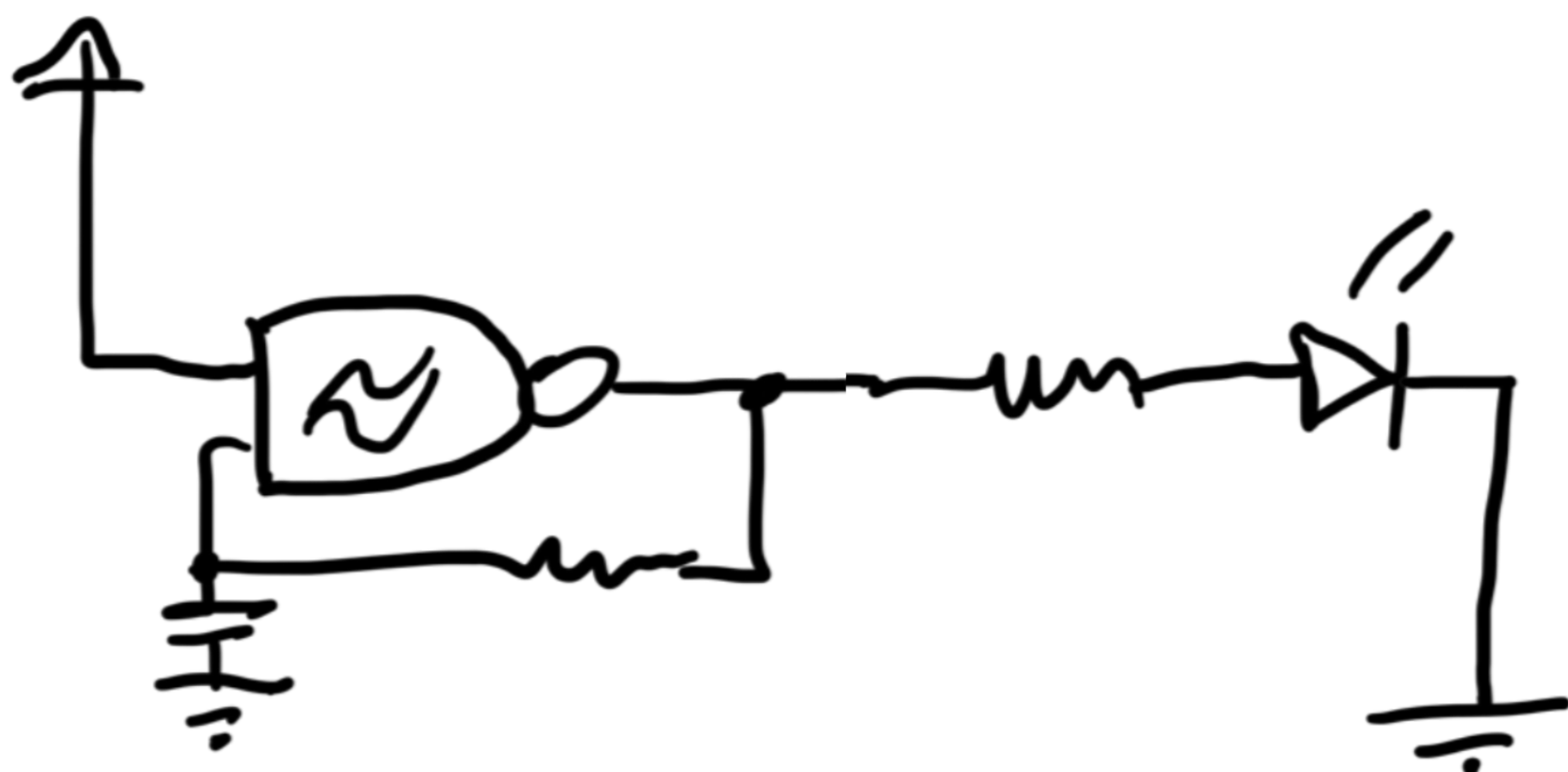
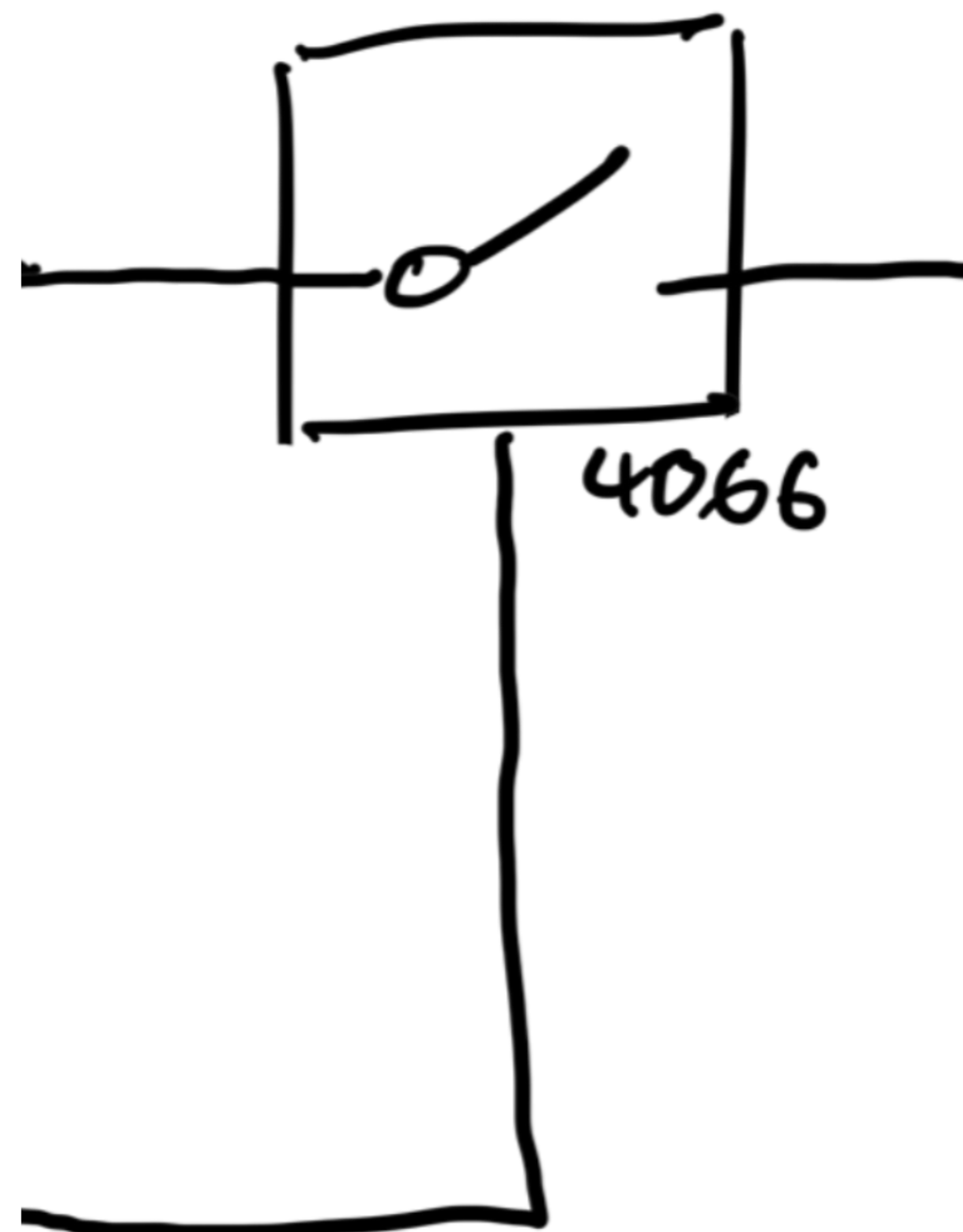
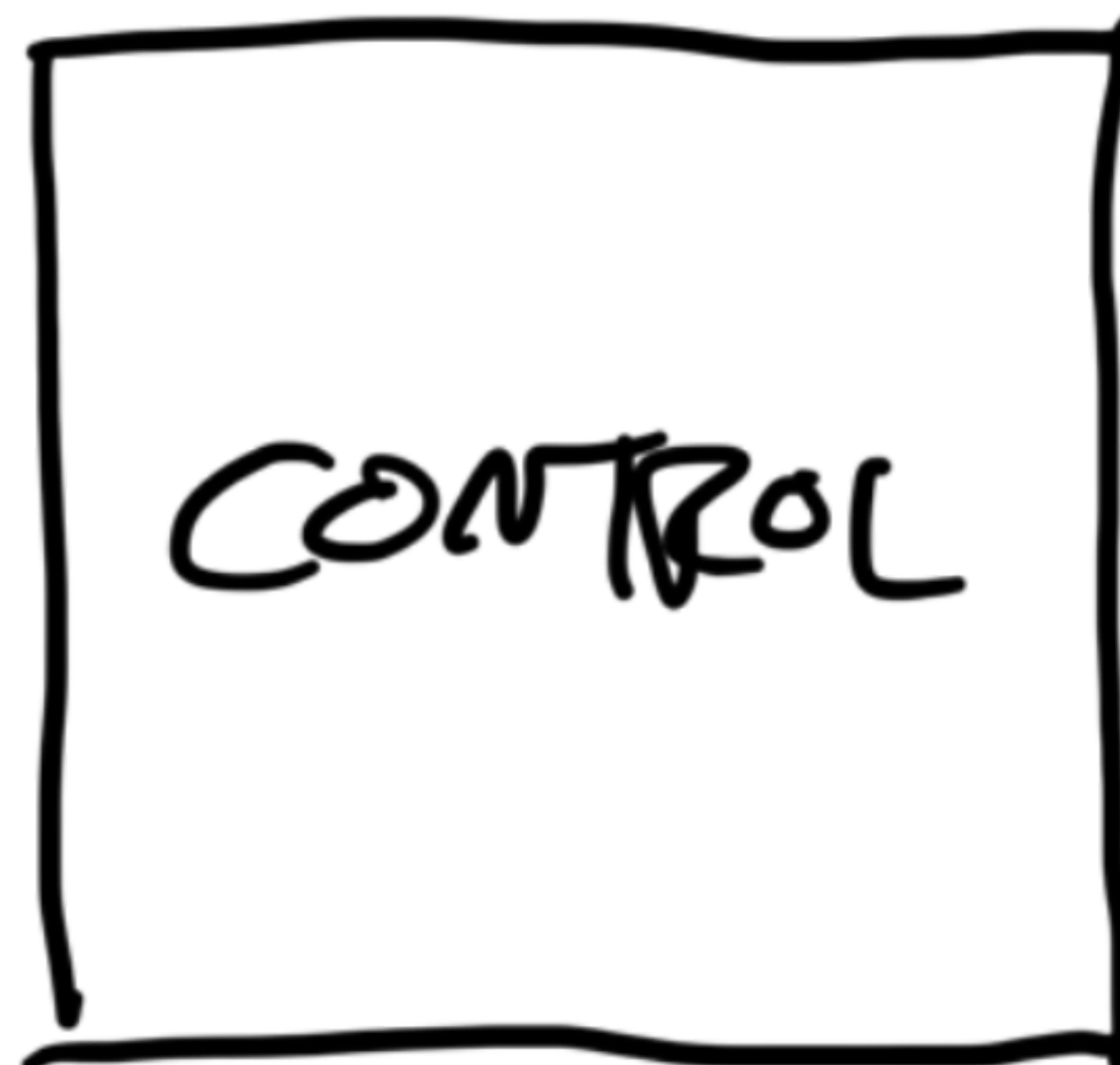
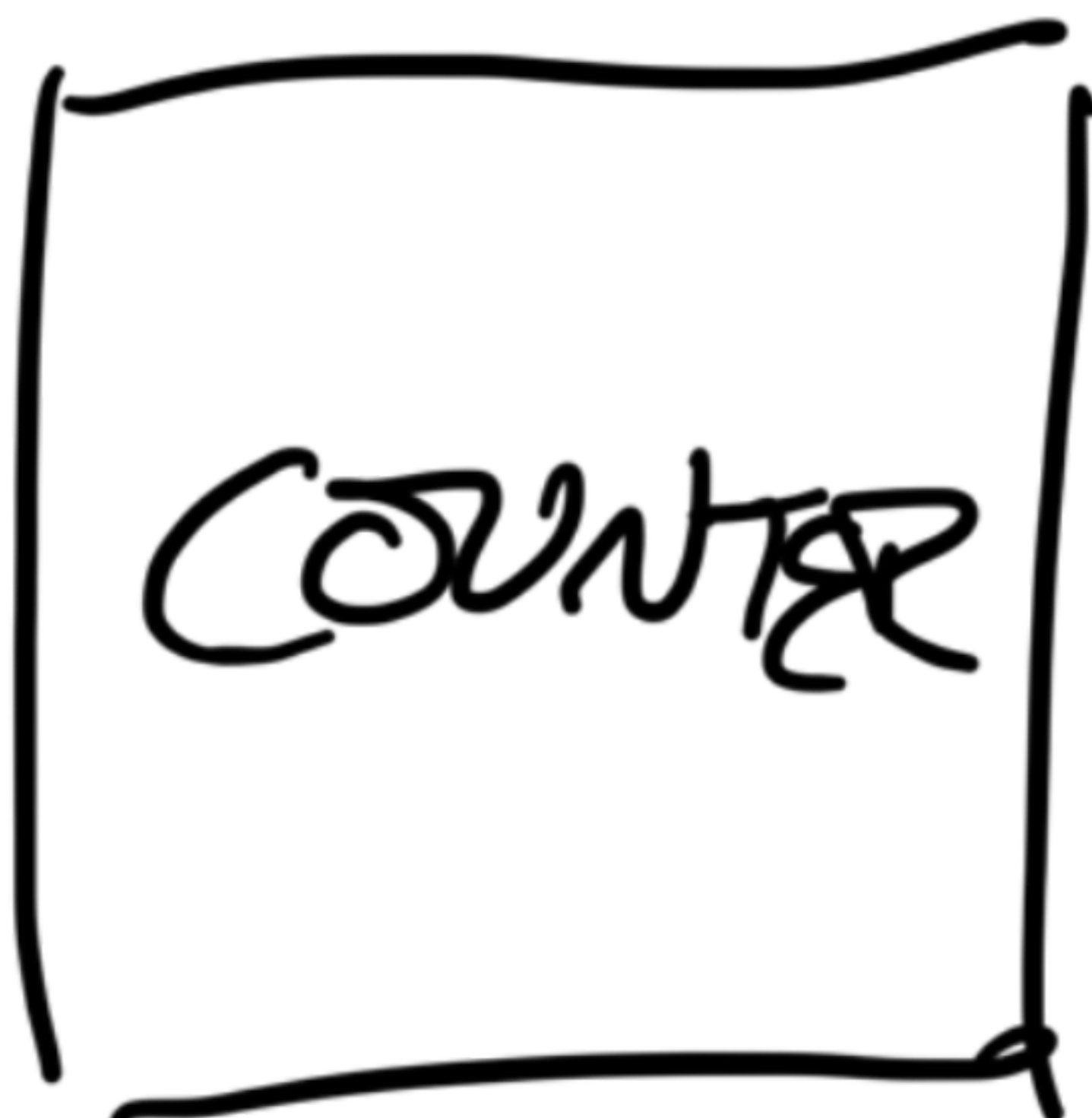
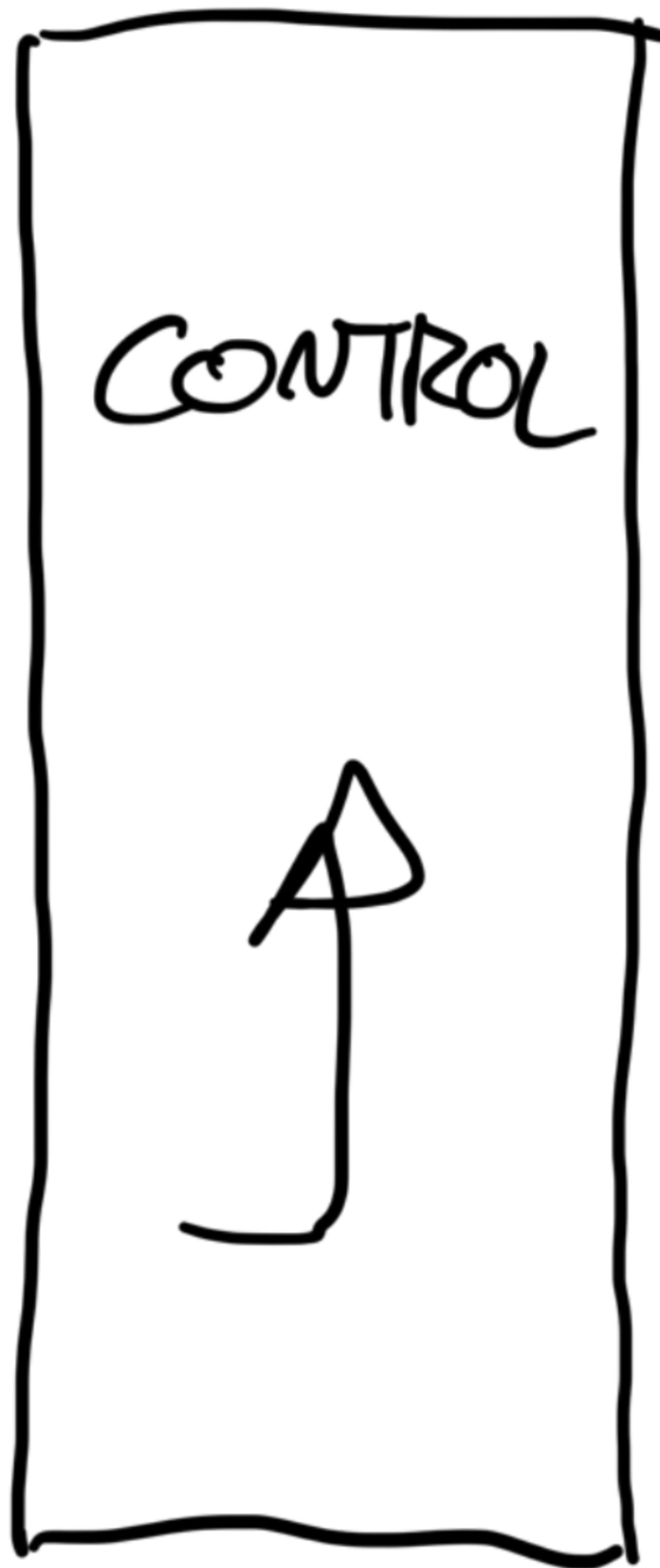

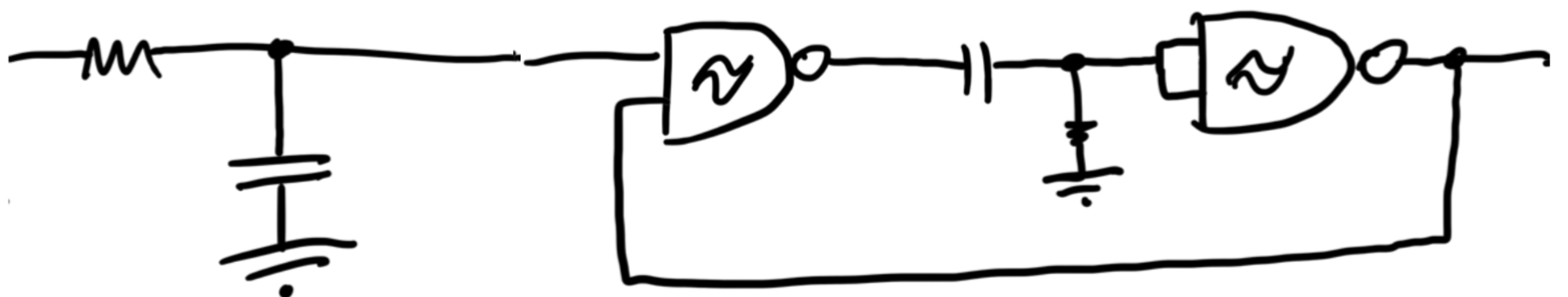
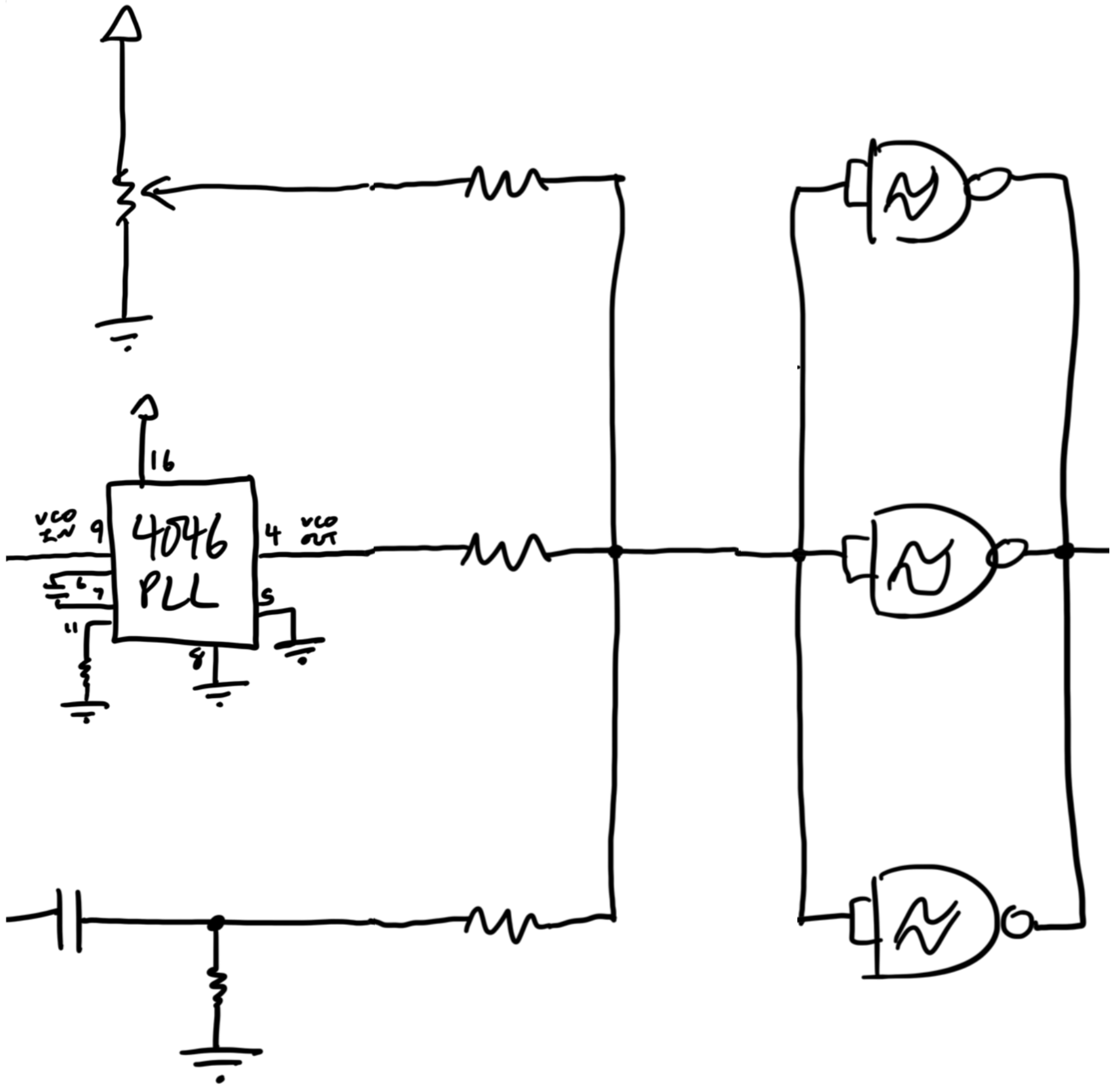

BOOSTER

MIXER

POWER

OSC

FILTER
(High Pass)

MONOSTABLE

FILTER
(Low Pass)

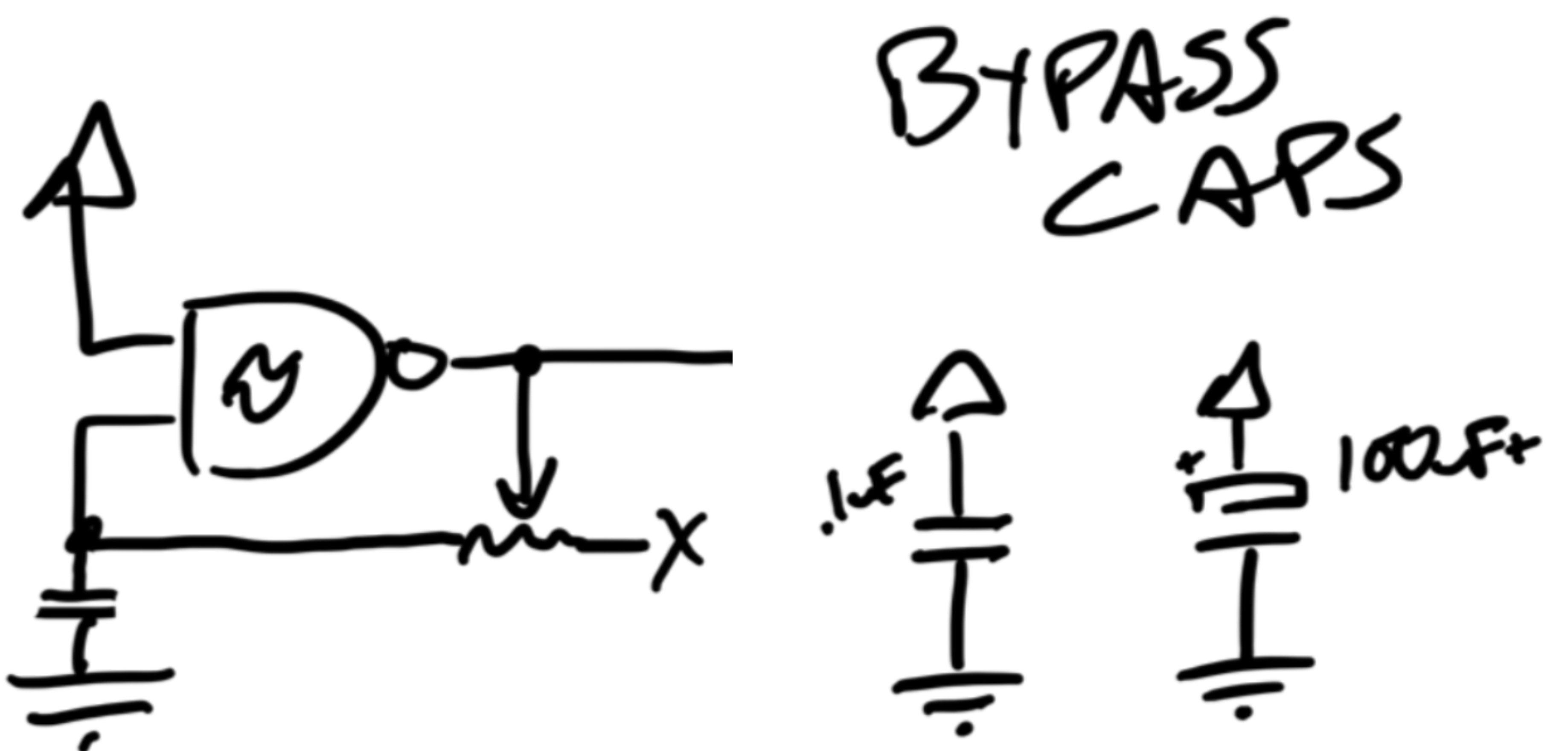
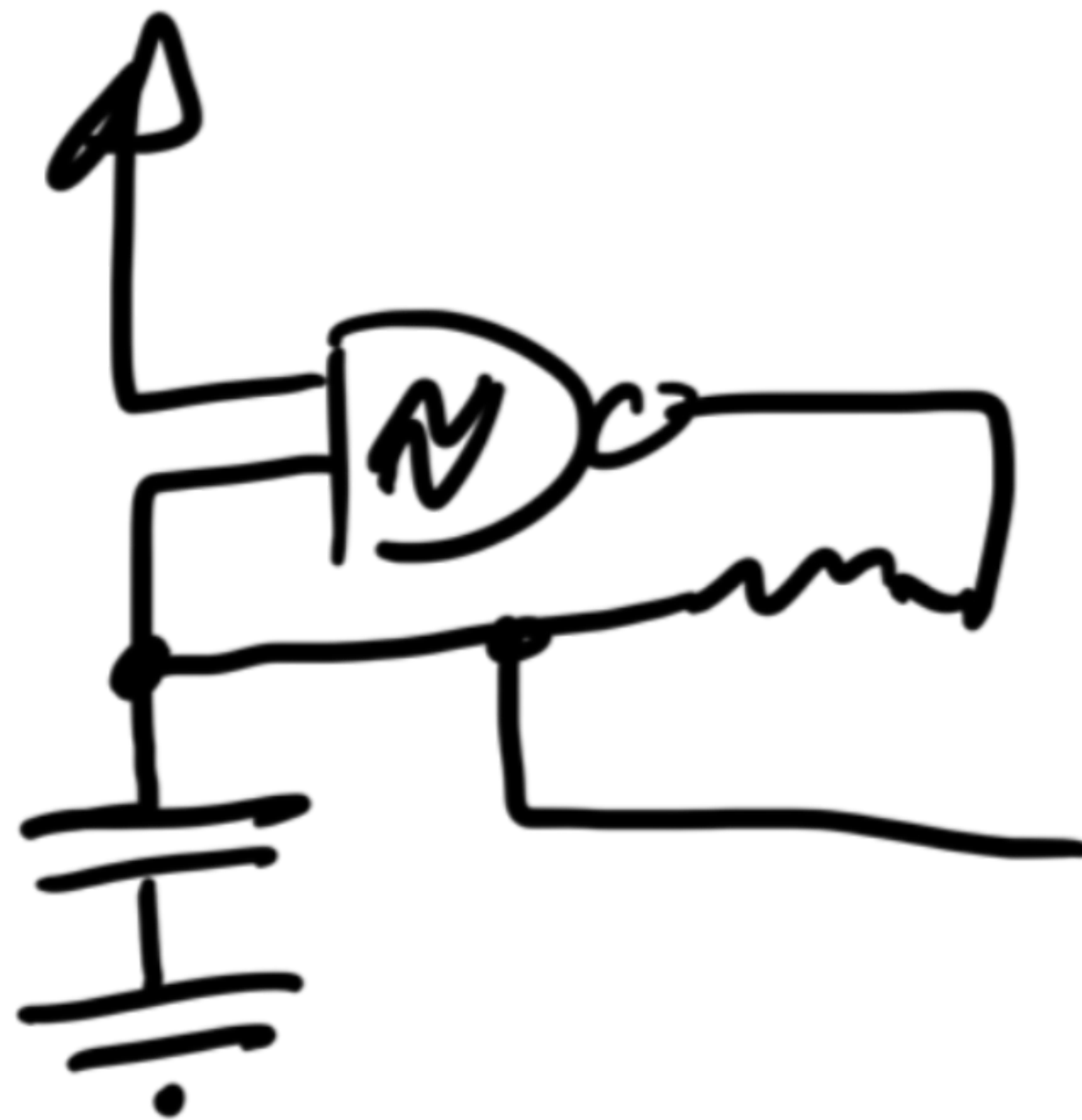
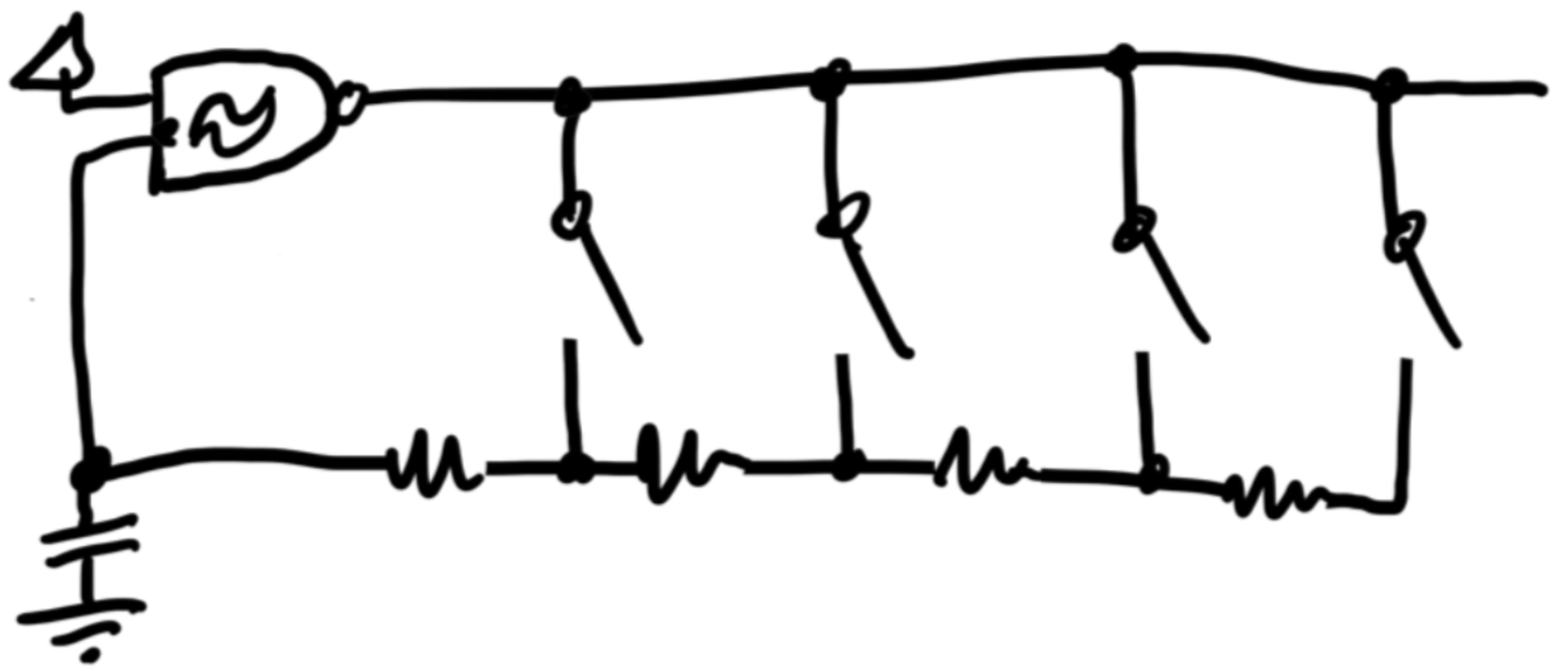
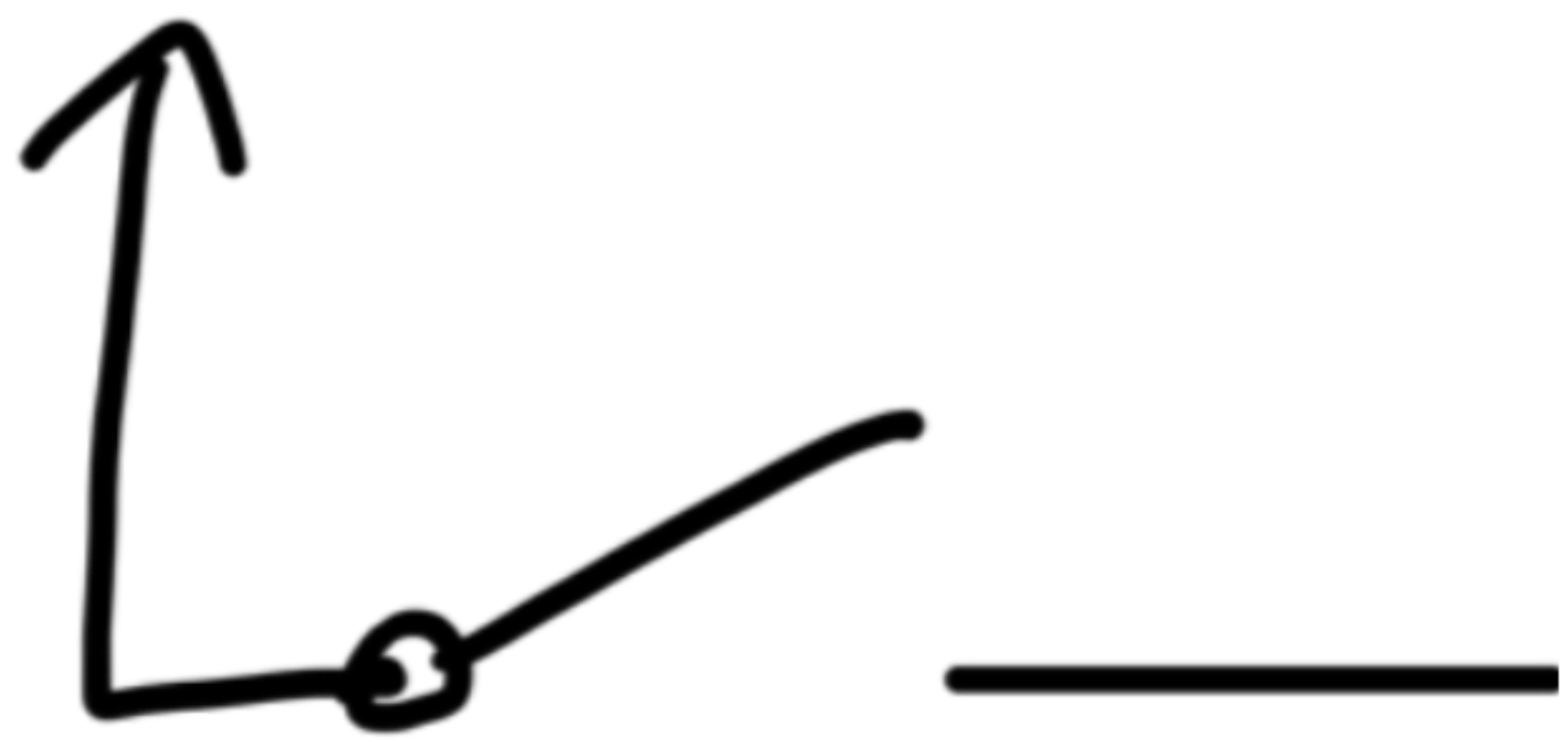
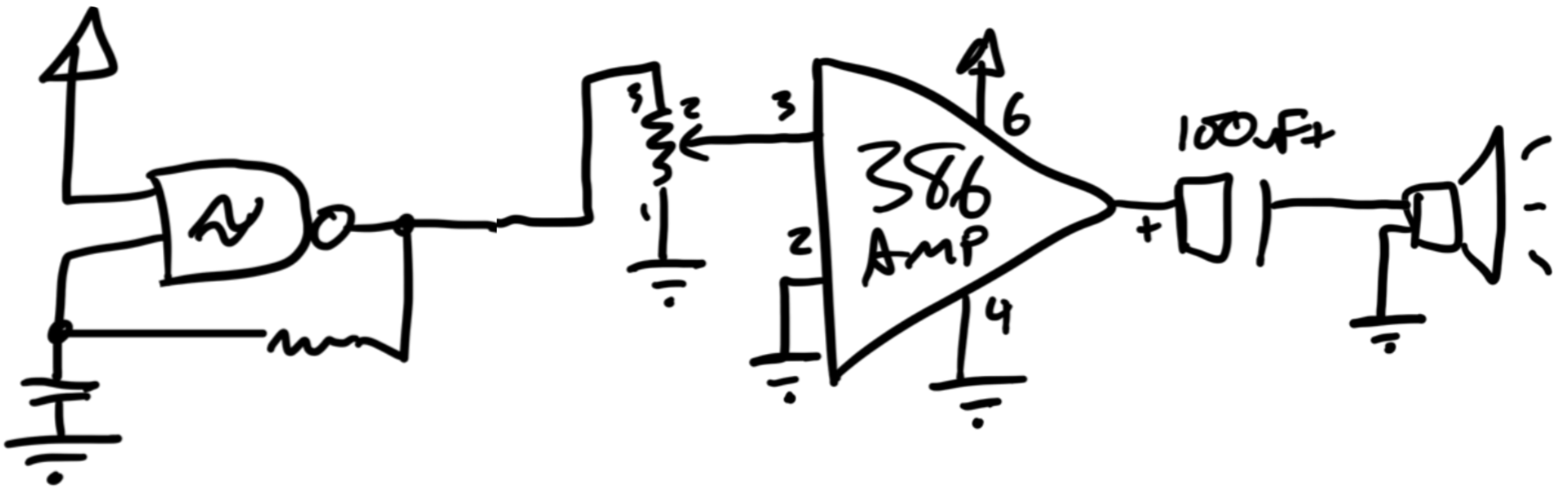
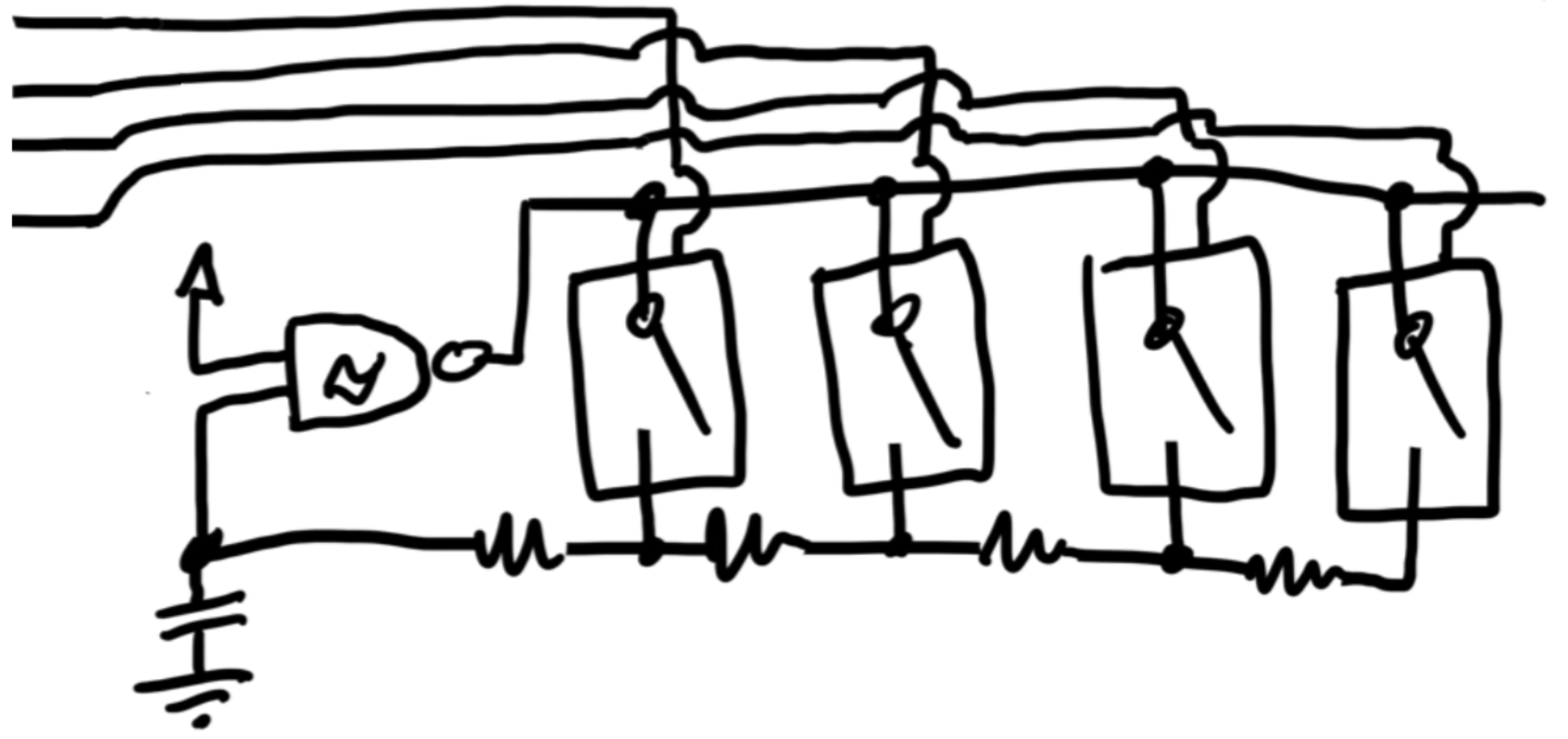

OSC

DISPLAY

AMP

OSC

OSC

POWER
CONTROL

OSC

OSC

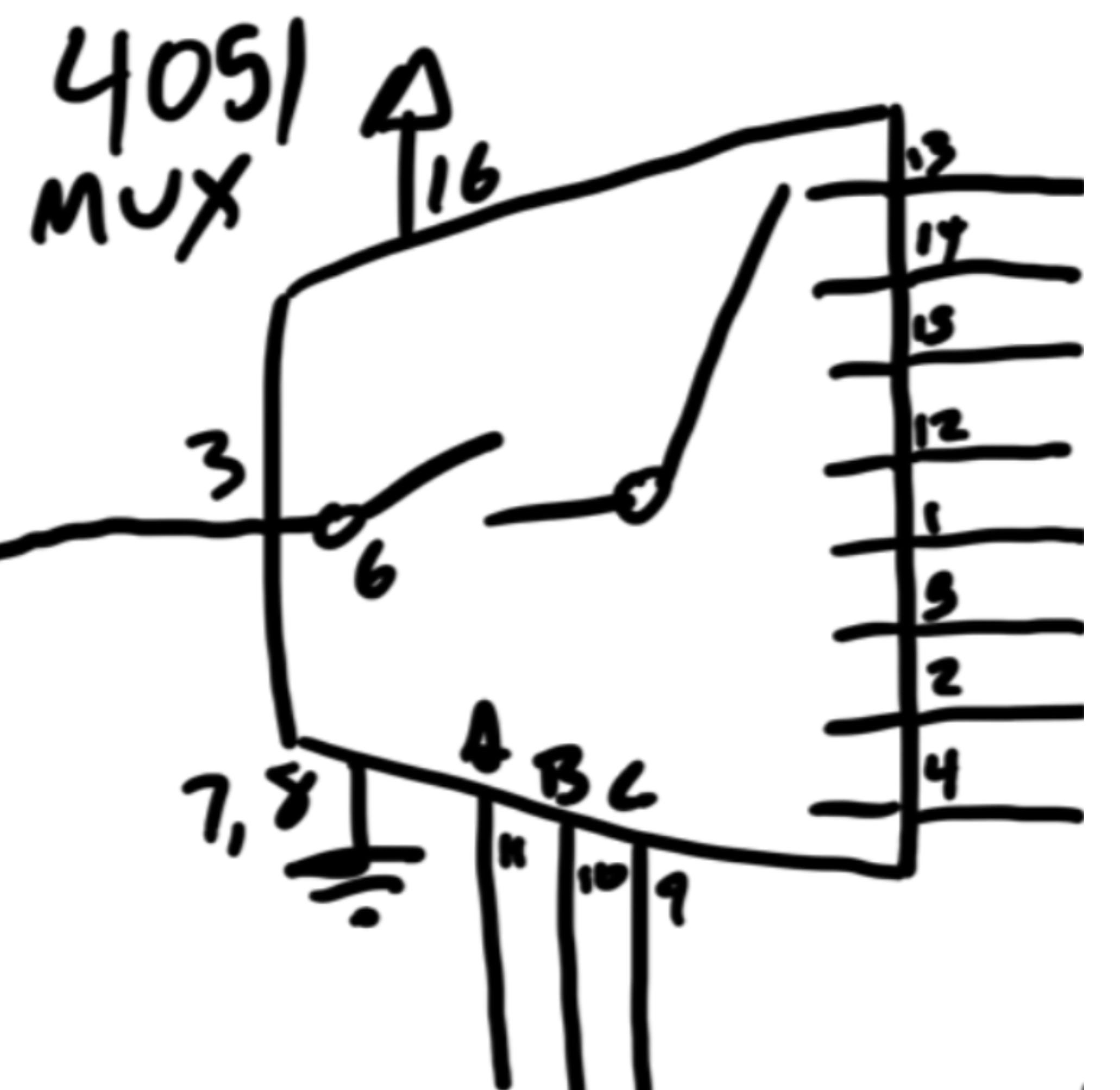
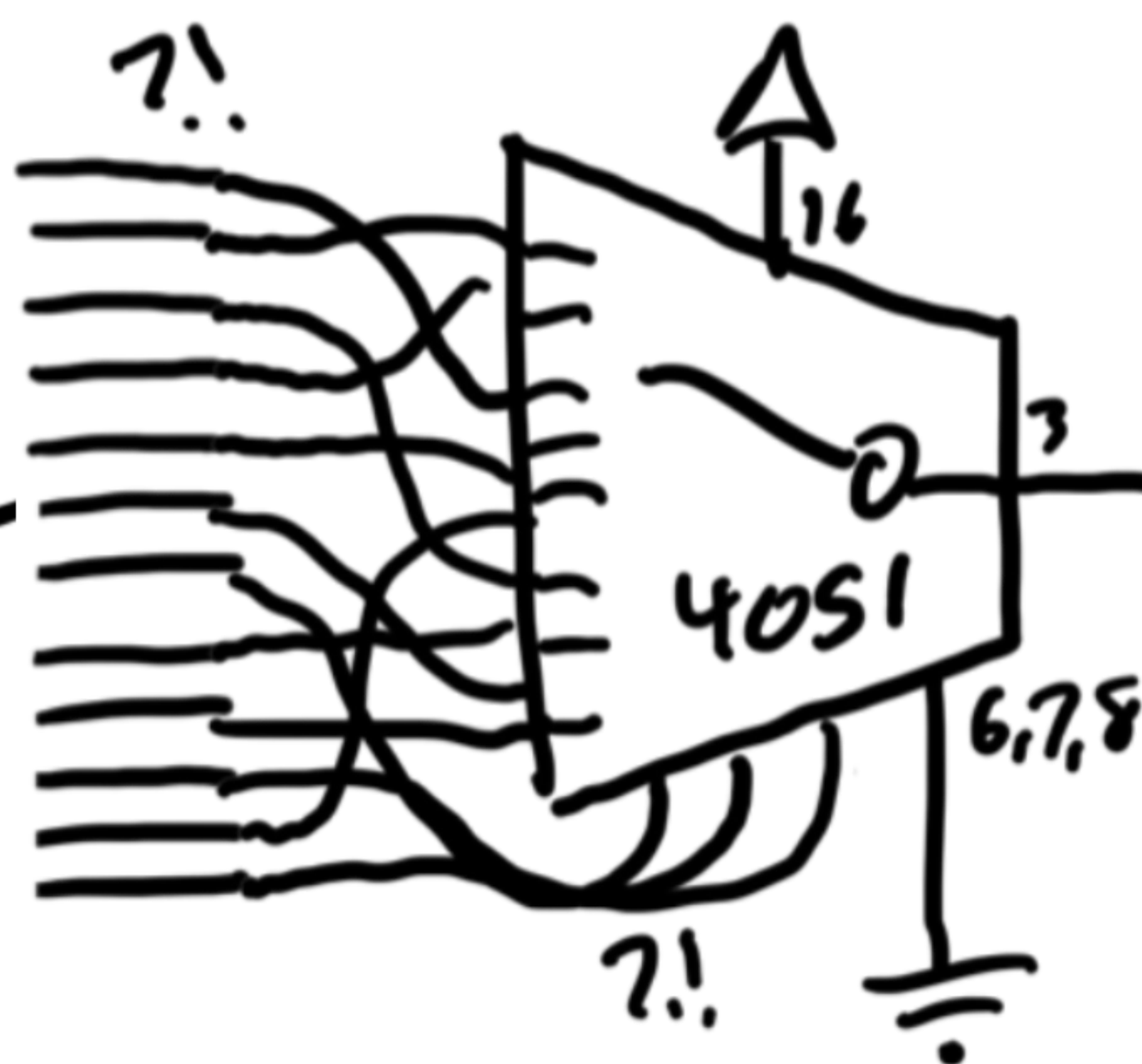
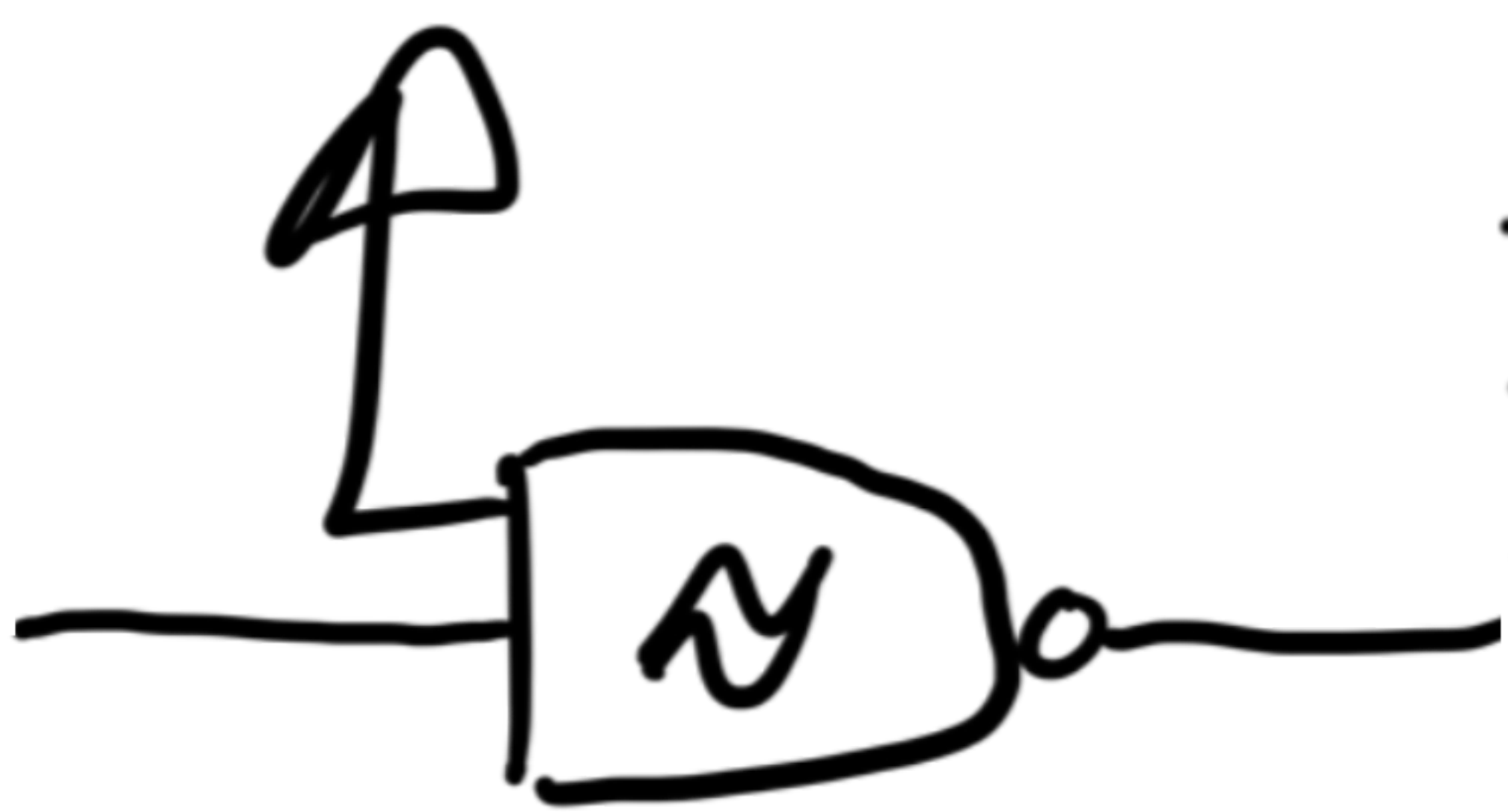
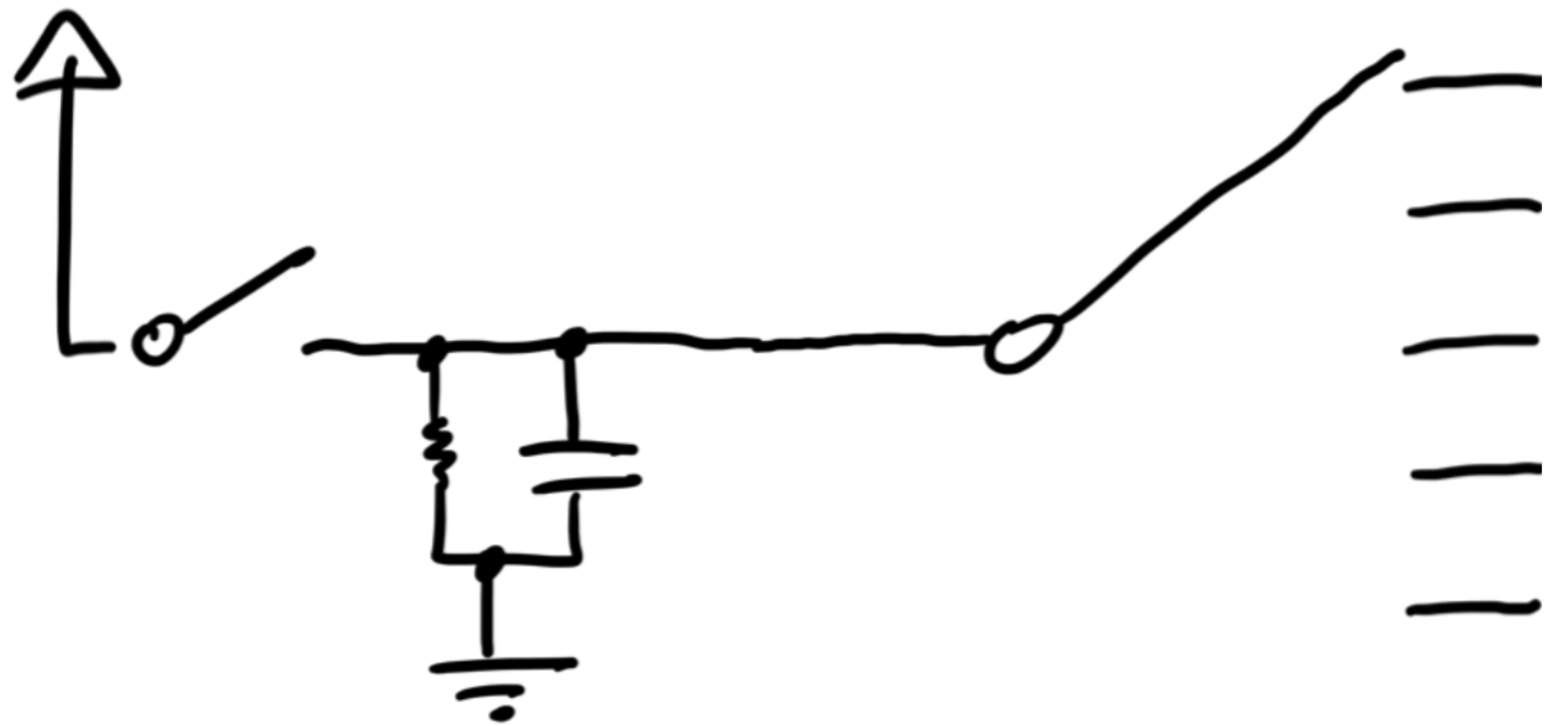
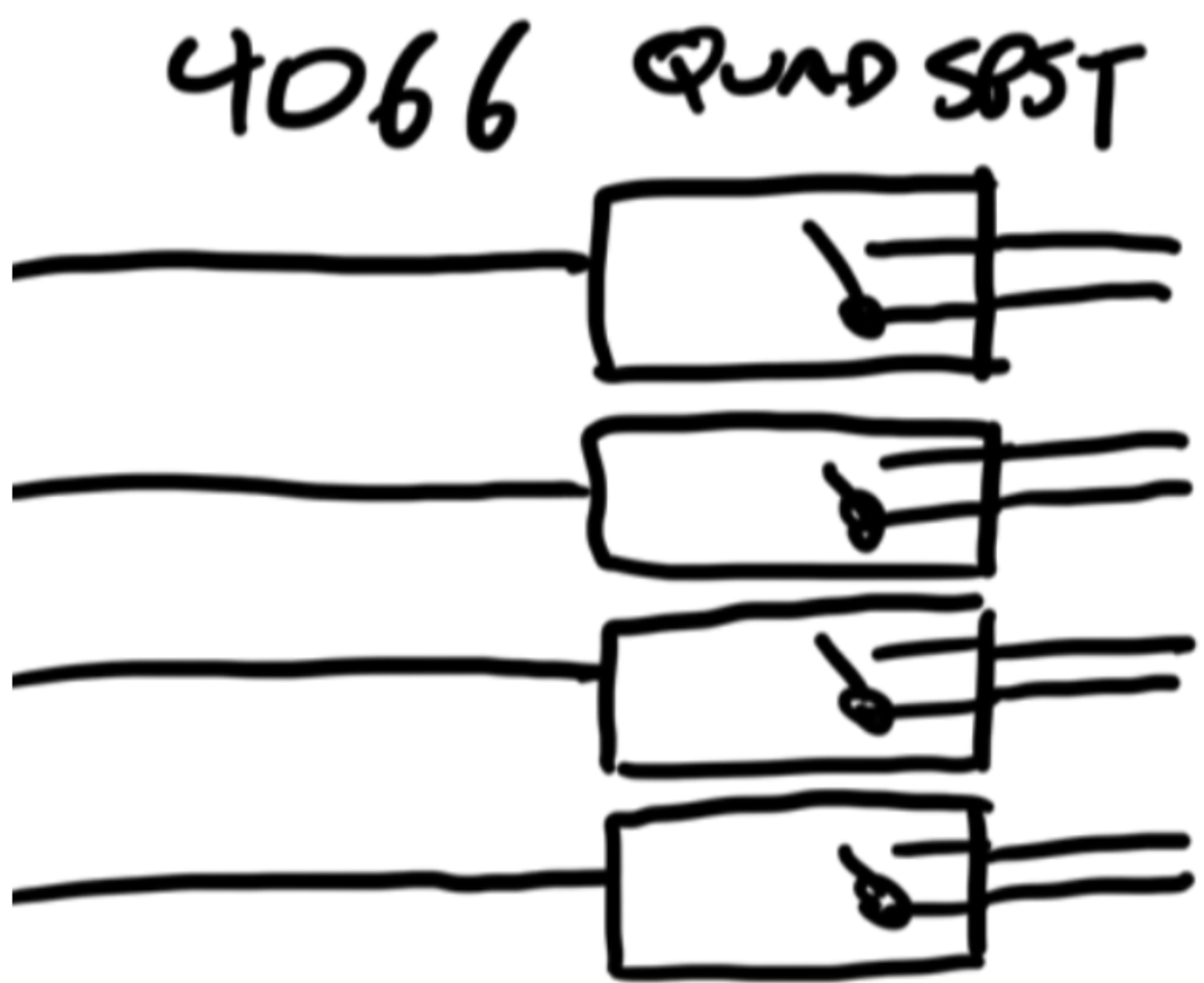
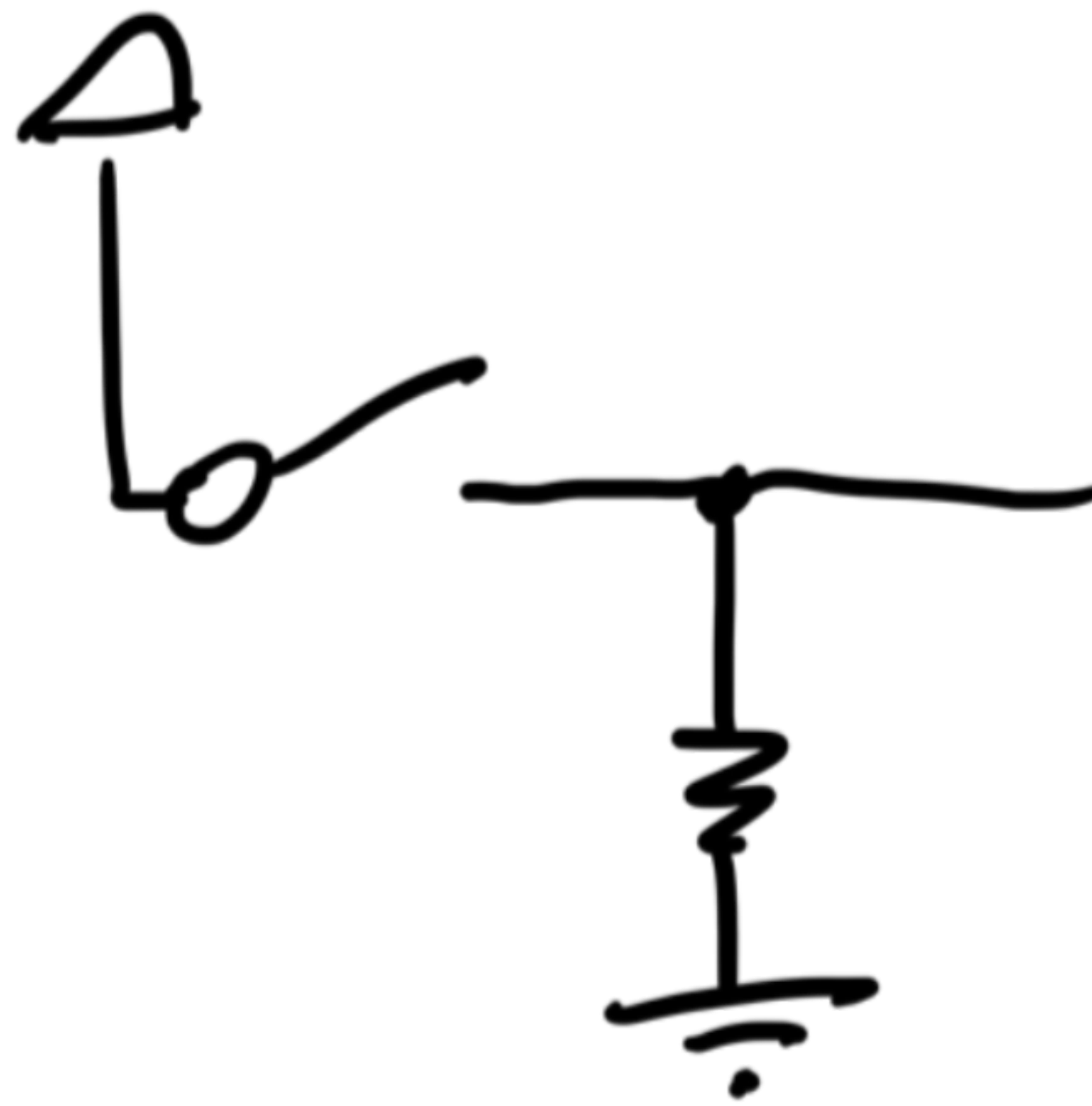
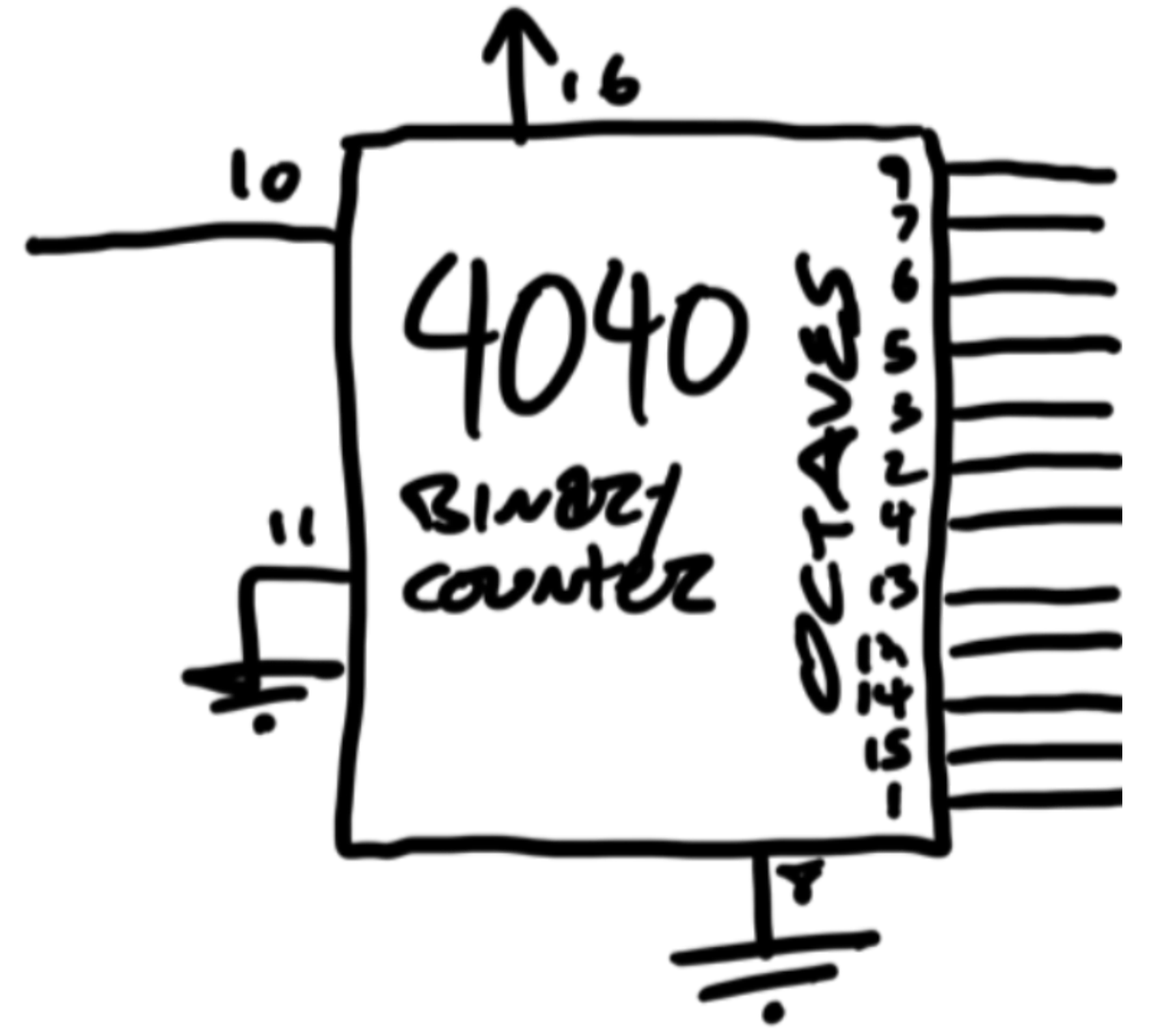
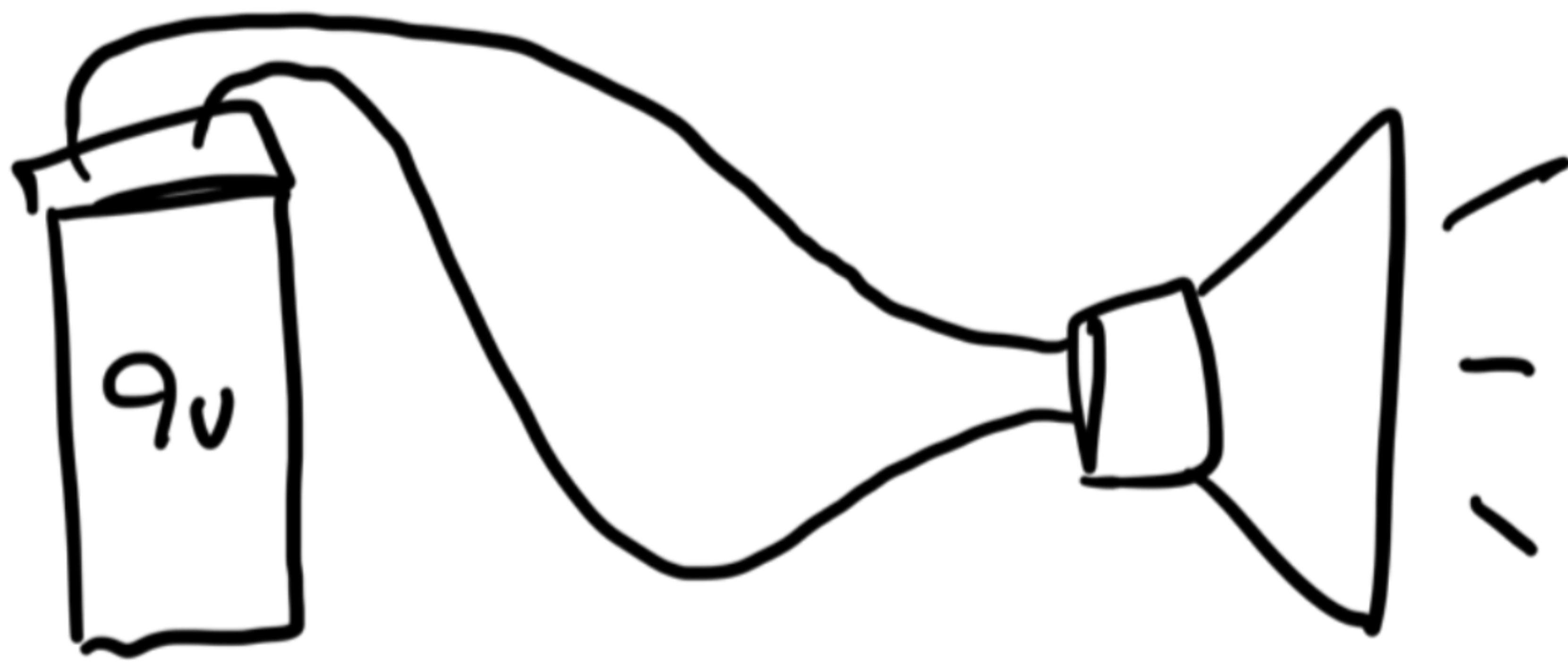

COUNTER

DISPLAY

POWER

POWER
CONTROL

CONTROL

POWER
CONTROL

CONTROL

CONTROL

CONTROL

NOT